

Design Data	
Commutation	Brushed
Direction of rotation	Bi-directional
Bearing type	A:Ball - B:Sleeve

Performance data		
Rated voltage [V]	U_N	12
Nominal torque [Nm]	M_N	6.00
No-load speed [min^{-1}]	n_0	52.0
Nominal power [W]	P_N	29.7
Nominal current [A]	I_N	6.0
Nominal force [kN]	F_N	0.00
Duty cycle	s1	

0291 AL

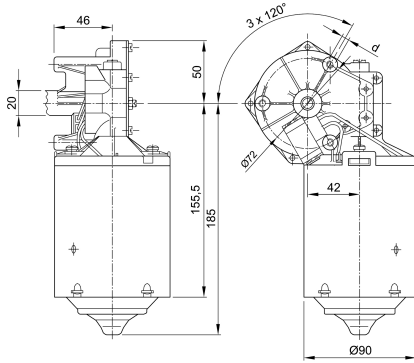

Sensor data	
Pulses	0
Output channels	0

Other data	
Gear ratio	59/1
Gear wheel material	Resinbonded fabric
Suppression components	
Enclosure class	IP 20
Weight [kg]	2.900

Remarks: d = M6x16mm

Motor picture



Characteristic curves

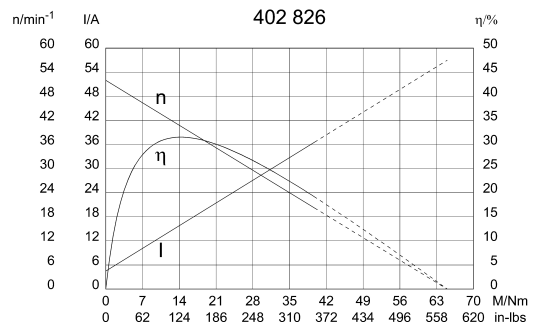

Output shaft drawing (W), Wiring diagrams (S) and Connector layout (K)

W 278

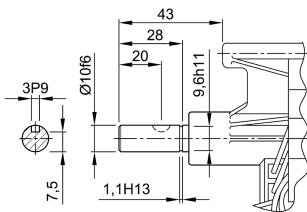

S 28

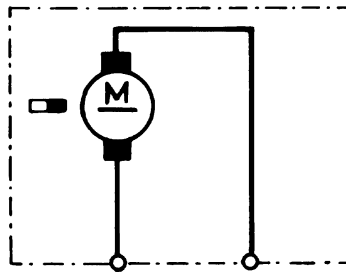

K 243

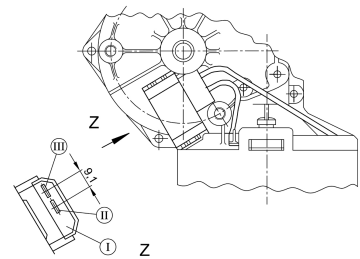

Flat plug 6,8x0,8 DIN 46244 mating with receptacle for tabs and connector housing 163 006-1, drwg C163006, www.tycoelectronics.com