

Design Data	
Commutation	Brushed
Direction of rotation	Bi-directional
Bearing type	

Performance data		
Rated voltage [V]	U_N	12
Nominal torque [Nm]	M_N	0.24
No-load speed [min^{-1}]	n_0	17.0
Nominal power [W]	P_N	0.37
Nominal current [A]	I_N	0.0
Nominal force [kN]	F_N	0.00
Duty cycle		s3

Sensor data	
Pulses	0
Output channels	0

Other data	
Gear ratio	109/1
Gear wheel material	
Suppression components	
Enclosure class	IP40
Weight [kg]	0.180

Remarks:

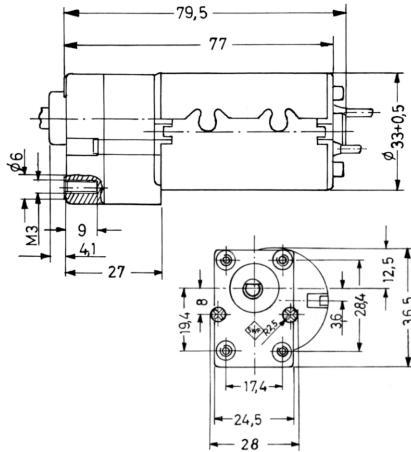

Motor picture

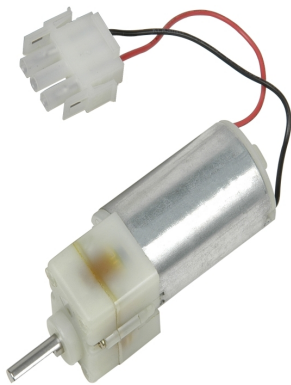

Characteristic curves

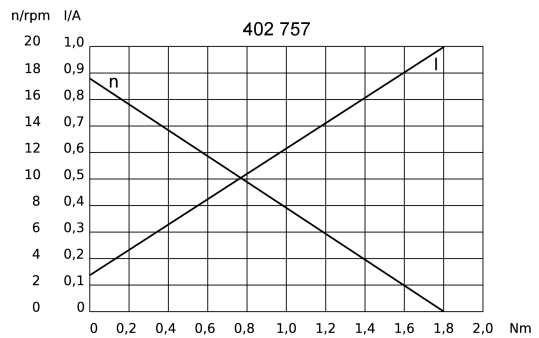

Output shaft drawing (W), Wiring diagrams (S) and Connector layout (K)

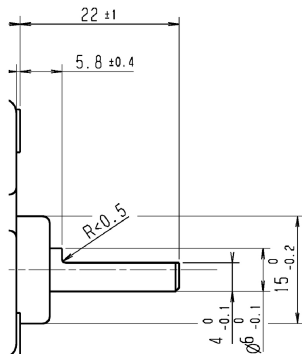

S 30

